

Results from the WhiteRabbit sub-nsec time synchronization setup at HiSCORE-Tunka

M.BRÜCKNER¹, R.WISCHNEWSKI², S.BEREZHNEV³, N.BUDNEV⁴, M.BUEKER⁵, O.CHVALAEV⁴, A.DYACHOK⁴, U.EINHAUS⁵, S.EPIMAKHOV⁵, O.GRESS⁴, D.HAMPF⁵, D.HORNS⁵, N.KALMYKOV³, N.KARPOV³, E.KONSTANTINOV⁴, E.KOROSTEVA³, M.KUNNAS⁵, V.KOZHIN³, L.KUZMICHEV³, B.LUBSANDORZHIEV⁶, N.LUBSANDORZHIEV⁶, R.MIRGAZOV⁴, R.MONKHOEV⁴, R.NACHTIGALL⁵, A.PAKHARUKOV⁴, M.PANASYUK³, L.PANKOV⁴, E.POPOVA³, V.PROSIN³, V.PTUSKIN⁷, G.ROWELL⁸, YU.SEMENEY⁴, B.SHAIBONOV⁶, A.SILAEV³, A.SILAEV(JU)³, A.SKURIKHIN³, L.SVESHNIKOVA³, M.TLUCZYKONT⁵, I.YASHIN³, A.ZAGORODNIKOV⁴, V.ZIRAKASHVILI⁷

¹ *Institute for Computer Science, Humboldt University, Berlin, Germany*

² *DESY, Zeuthen, Germany*

³ *Institute of Nuclear Physics, MSU, Moscow, Russia*

⁴ *Institute of Applied Physics ISU, Irkutsk, Russia*

⁵ *Institut für Experimentalphysik, University of Hamburg, Germany*

⁶ *Institute for Nuclear Research of RAS, Moscow, Russia*

⁷ *IZMIRAN, Troitsk, Moscow Region, Russia*

⁸ *School of Chemistry and Physics, University of Adelaide, Australia*

ralf.wischnewski@desy.de

Abstract: The HiSCORE detector, a new non-imaging wide-angle Air-Cherenkov ground based array, is currently in its engineering phase. Time synchronization to nsec-level between detector stations, distributed over 10-100km², is essential to reach best angular resolution for high energy gamma rays.

A dedicated time-synchronization and trigger time-stamping system has been developed, and is operating at the Tunka site since October 2012. The system is based on White Rabbit, a new synchronization standard using synchronous Gigabit Ethernet. This first White Rabbit application in a field setup confirms long-term operation with nsec clock precision and phase stability to sub-nsec level; the system is ready for use.

Keywords: Gamma Astronomy, White Rabbit, Instrumentation, new technologies.

1 Introduction

The HiSCORE detector, a new non-imaging wide-angle Air-Cherenkov ground based array, is currently in its engineering phase [1, 2, 4]. Time synchronization down to the ns-level between detector stations, distributed over 10-100km², is essential to reach best angular resolution for high energy gamma rays [3].

A variety of proprietary solutions for ns-time synchronization of large-scale astroparticle-physics experiments have been developed in the past. With the new White Rabbit technology now available, we decided to test this candidate for a new experimental time-synchronization standard. We follow the adaptation described in [9], and performed a first long-term field test with the HiSCORE prototype stations deployed in fall 2012 [4].

The paper is organized in the following way. In section 2 we review the main features and components of White Rabbit (WR), and introduce the application specific modifications of the WR-nodes made in [9] for this project. Section 3 describes the field setup, designed to yield a maximum of WR-performance information by self-testing redundant WR-components against each other. Section 4 draws the conclusion, that the presented WR-technology is performing very well and is ready for use in large scale applications, and will likely become a new standard for high-precision timing in experimental astroparticle physics.

2 White Rabbit system - brief review

The time synchronization setup used for this experiment is based on White Rabbit [6], an open source, commercially available system with an active user community. White Rabbit is build on Gigabit Ethernet (1000base-BX10) and takes advantage of the Ethernet standards SyncE and Precision Time Protocol. It offers sub-ns precision, with excellent clock phase stability. It utilizes one fiber for each WR-node for both synchronization and user data, and compensates for clock drifts by environmental influences (e.g. temperature).

A White Rabbit setup is made up of a central WR-switch, acting as a master clock, and the WR-nodes (the “user modules”) - both connected by WR-fibers, either directly or via additional WR-switches (see eg. [6, 9]). As WR node device the “Simple PCIe FMC carrier” (SPEC) is used, which has a Spartan-6 FPGA (with the WR PTP Core, optional custom firmware and software) and can accommodate mezzanine cards with FMC-formfactor. Various FMC cards (IO, ADC, TDC, etc) are available, which define the SPEC-card functionality. The SPEC has a slot for SFP modules (for the White Rabbit fiber connection) and a USB terminal connector for status information. As mezzanine card we use the FMC-DIO5Ch, a 5 channel card originally designed to realize digital input/output channels connected to the FPGA. Typically, one output gives access to the WR FPGA-clock signal “PPS”, for easy debugging and performance tests.

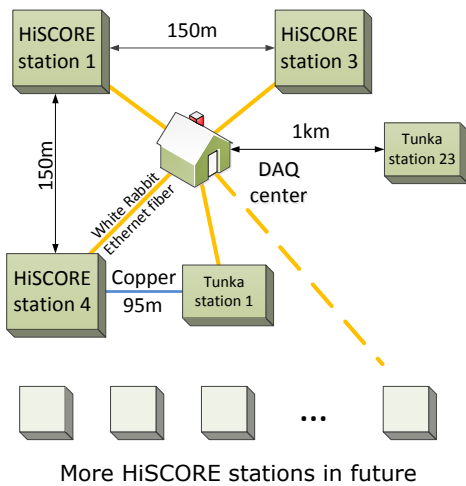

Figure 1: Layout of the HiSCORE prototype stations operated in the 2012/13 season: three stations at 150m distance. The WR-master switch, connected to all WR-nodes, is located in the DAQ-center; also shown are Tunka-stations 1 and 23 (for details see fig.4).

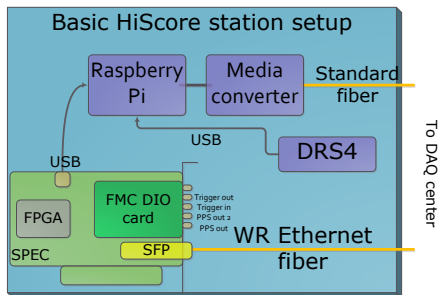

Figure 2: The basic White Rabbit setup, as contained in each HiSCORE prototype station: WR-node (SPEC card) with WR-fiber, Raspberry Pi and DRS4.

As presented in [9], we developed a SPEC FPGA-design, that allows to

- (1) time stamp external trigger signals (externally generated), with ns-precision, and transfer the time-stamps and counter information via WR-fiber to the WR-master; or
- (2) form the trigger decision on the WR-node by ns-sampling of an analog input signal, discriminated against a comparator threshold; a trigger being generated after $\geq N$ consecutive ns-samples being high. (N typically set to 9 ns). The trigger signal is time-stamped, like for (1), and additionally generates an Trig_Out signal on the FCM-DIO5Ch to initiate the FE/DAQ-readout.

We mention that the White architecture guarantees that the clocks in each WR-node is synchronized with full precision at any time. This is an essential difference compared to most proprietary time-synchronization solutions in experiments, based on corrections applied offline (or with significant delay).

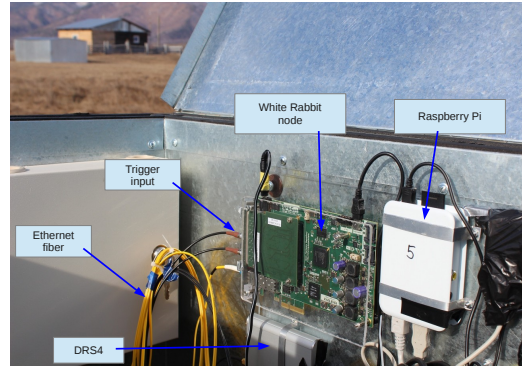

Figure 3: A HiSCORE prototype station with components of the DAQ and White Rabbit (see also fig. 2).

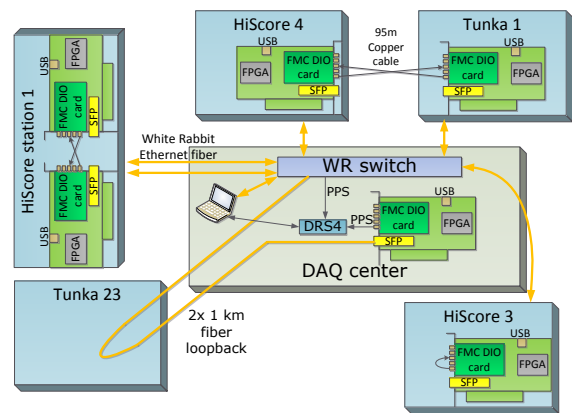

Figure 4: The complex WR-test setup for the HiSCORE prototype installation, as operated in 2012/13 to verify the time-synchronization and trigger time-stamping. For the upgrade for WR-selftriggering on PMT-signals, see text.

3 Field setup and performance test

3.1 HiSCORE prototype setup of 2012/13

Three HiSCORE prototype detector stations were installed in October 2012 [4], as sketched in fig. 1. They operated until April 2013, in parallel with the cosmic ray Cerenkov detector Tunka-133 [5], to test the basic functionality of the optical stations, and to cross-calibrate with airshowers measured by the Tunka-133 Cerenkov array.

3.2 The field setup

To verify the field performance of the White Rabbit system, a basic HiSCORE WR-setup was installed in each station, as shown in fig. 2. It consists of the WR-node (SPEC card), with a fiber connecting to the WR-switch in the central DAQ station. The SPEC USB-terminal port (to access WR-status information) is interfaced to a Raspberry Pi PC, connected by a separate Ethernet fiber connection. Measurement of the time jitter of WR-signals to sub-nsec scale is done by an DRS4-evaluation board (DRS4-EB), with up to 5 GHz waveform sampling capability, which in turn is read out by the Raspberry. Through this fiber link, also the bulk data from the optical sensors are transferred to the center, which come from the prototype HiSCORE readout DAQ (based on DRS4 Evaluation boards, not shown on fig. 4).

The full White Rabbit installation is given in fig. 4. This first field is based on WR-components only, allowing for cross-verification by partially redundant components.

Station HiSCORE-1 (HiS-1) contains two WR-nodes, that send their PPS pulses to the neighbour's trigger-input. Both WR-nodes are operating on separate fibers. HiS-4 and Tunka-1 are connected by a 96m long double-coax cable; and are setup for the same PPS cross-calibration as HiS-1. HiS-3 is a standalone WR-node. The DAQ-center houses the master WR-switch and a WR-node, connected through a 2x1km fiber to the far-away Tunka-23 station; this "2km-fiber loopback setup" allows to study environmental and long-term effects.

3.3 Results

The above described setup allows to verify the instantaneous performance of the clocks at any moment (phase of the inter-connected clocks), as well as the stability and precision of the trigger-time latching. Apart from the important check, if short time-scale instabilities or clock drifts occur (even if extremely rarely), we also verify the long-term reliability of all components.

First, we present results on the "2 km-fiberloopback" setup, as described in fig. 4. The time difference between PPS pulses from the clock-master (WR-switch) and the WR-node, $\Delta T = T_{WRS} - T_{SPEC}$ are shown in fig. 5 as function of time, for a typical run of 14 hours, as measured by a DRS4-EB with 5 GHz sampling rate. The histogram (insert) shows the ΔT -distribution, the measured rms of < 0.2 ns is extremely good (and close to the precision of the measurement).¹ We emphasize the absence of any non-statistical fluctuations in this (and all other) runs.

A run during extreme ambient temperature variations is presented in fig. 6, lasting for three consecutive days. The upper panel gives ΔT (averaged over 1000 sec to see trends). The middle panel shows the ambient temperature - up to 30°C changes, which lead by which result in fiber-propagation delays (Cable-RTT, measured by the WR-system) of up to 1.5 ns (lower panel). We note, that no drift of ΔT beyond 0.2 ns was observed (slow long-term drifts in the applications could even be tolerated and calibrated).

Figure 7 shows the difference between time stamps of the PPS-signals sent from Tunka-1 over 96 m coax cable to HiS-4 (see fig. 4): The HiS-4 clock measures with its own clock the stability of the time difference of 1.00 sec between neighbored PPS signals; thus confirming both clocks to be synchronous²

The other cross-verification setups shown in fig. 4 give the same confirmation of stability and absence of non-statistical fluctuations.

We note, that the measurement results presented here are based on synchronous test signals (PPS). For the clock stability test with random signals, the same excellent performance and stability was observed - as we have shown in the laboratory measurements reported in [9].

In April 2013, the setup from fig. 4 was upgraded, by installing the firmware for the WR self-trigger (see sect.2 and [9]), and triggering on the analog PMT anode-sum signal in all three HiSCORE stations. The ns-precision trigger time-stamps from all stations were recorded and used to synchronize the GHz waveform data from the DRS4-boards, allowing for reconstruction of the shower arrival direction from the HiSCORE prototype stations (plane wave approximation).

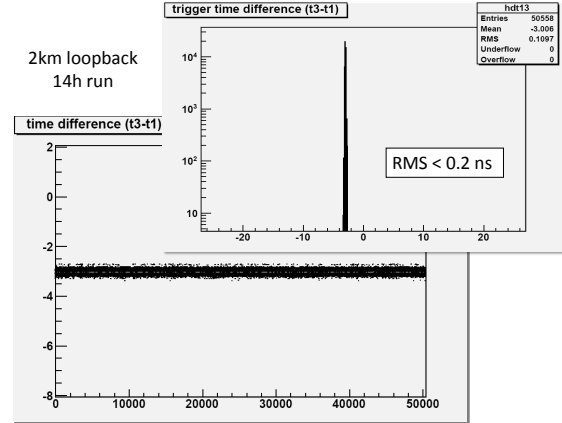

Figure 5: Time difference between PPS pulses from clock-master (WR-switch) and WR-node, T_{WRS} and T_{SPEC} (y-axis, in ns) for 2 km fiber length, as function of time (x-axis, in sec), for a 14 hr run. The histogram gives the distribution with rms < 0.2 ns.

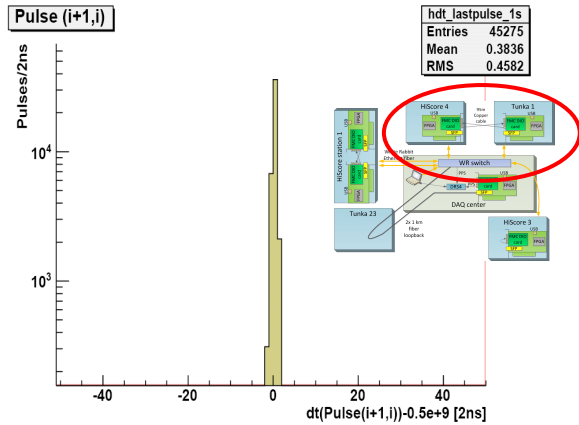

Figure 7: Time difference $dt(\text{Pulse}(i+1),i)=t_{i+1}-t_i$ between consecutive PPS pulses sent from Tunka-1 to HiS-4 for time-stamping, compared to the expectation value of 1.00s.

4 Conclusions

We developed and installed a White-Rabbit based setup for nsec-timing and clock-synchronization of the Tunka-HiSCORE prototype stations. It time-stamps external trigger with nsec precision, or alternatively can directly analyze the analog PMT signals in nsec-slices and derive a trigger signal. The current setup uses commercially available WR-hardware, the FPGA firmware of the nodes has been adapted [9]. For special interfaces, custom mezzanine cards can be developed, based on the open-source documentation.

We find for a variety of test conditions and field setups

- WR-node clock stability, of rms_{phase} < 200 ps,
- trigger time stamping precision of 1 ns.

1. The offset of ~ 3 ns is due to a trivial cable length difference in the DRS-4 measurement setup.
 2. Time-stamping on HiS-4 is in 2 ns steps, for this firmware version, therefore the normalization to $0.5e+9$ in fig. 7.

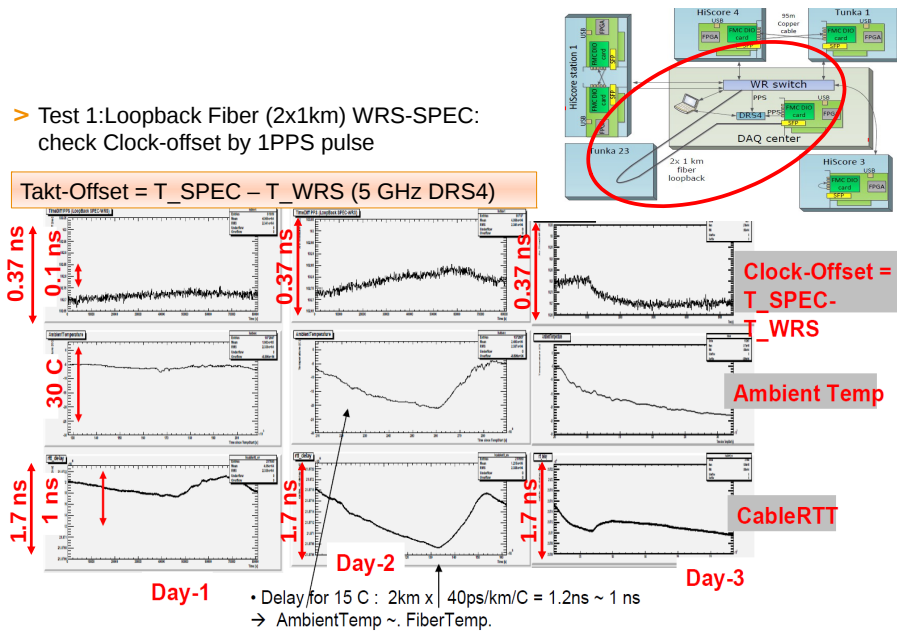

Figure 6: In-situ measurement of the sub-nsec WR-clock-stability by tracing the PPS-signal time difference between clock-master (WR-switch: T_{WRS}) and a WR-node (SPEC card: T_{SPEC}) (upper panel), averaged over 1000 sec. Test interval shown is three consecutive days, environmental fiber temperature changes were up to 30°C (middle panel), which result in fiber-propagation delays (Cable-RTT) of up to 1.5 ns (lower panel).

These field results are compliant with the experimental requirements, and fully agree with laboratory tests (and are close to the resolution of the measurement equipment).

We plan additional, independent tests with external calibration sources with the Tunka-HiSCORE installation in fall 2013: LED pulser light signals from terrestrial or airborne (octocopter) locations, as well as reference signals by the radio beacon method [10].

We mention an additional, so far only partially exploited feature of the WR-nodes - their use as high-precision synchronized output devices. It is easily possible to program the generation of time-synchronous test signal patterns in all detector stations, as well as complex time series down to few-nsec scale to be injected into single stations - thus imitating real event patterns at the nsec-scale; allowing for complex test and calibration options.

We note the excellent system reliability: not a single component of four complete stations showed a failure over 6 months of Siberian winter performance (at operation/storage temperatures of $0\dots+30^{\circ}\text{C}$ / $-45\dots+10^{\circ}\text{C}$, respectively).

The setup presented here will be used for time-synchronization in the 10-station HiSCORE installation at Tunka, that will start operation in October 2013 [4]. It is also a candidate for the array-time synchronization and array-trigger in the Cerenkov Telescope Array project (CTA) [11]. We believe, that this first application in a field experiment will mark the begin of a success story of the White-Rabbit-technology as a new standard tool in experimental astroparticle physics for (1) sub-nsec clock synchronization, (2) event time stamping and (3) precision pulse generation.

Acknowledgment: We acknowledge very helpful discussions, technical advices and support from the White Rabbit com-

munity (in particular the CERN based team and A. Rubini) during all phases of this project. The technical support from both SevenSolutions and Creotech was very helpful.

We acknowledge the financial support of the Russian Federation Ministry of Education and Science (G/C16.518.11.7051, 14.740.11.0890, 16.518.11.7051, P681, contract N 14.518.11.7046), the Russian Foundation for Basic research (grants 10-02-00222, 11-02-12138, 12-02-10001, 12-02-91323), the President of the Russian Federation (grant MK-1170.2013.2), from the Helmholtz association (grant HRJRG-303) and the Deutsche Forschungsgemeinschaft (grant TL51-3).

References

- [1] M.Tluczykont, D.Hampf, D.Horns et al., *Advances in Space Research* 48 (2011) 1935-1941.
- [2] M.Tluczykont et al., *Nucl. Inst. Meth.* A692 (2012) 246.
- [3] D.Hampf, D.Horns and M.Tluczykont, *Nucl. Instr. Meth.* A712 (2013) 137-146
- [4] Tunka-HiSCORE-Collaboration, "Status of the HiSCORE experiment", these proceedings ID-1164
- [5] N.Budnev et al., "The Tunka experiment: status 2013", these proceedings ID-418
- [6] Pedro Moreira et al., *White Rabbit: Sub-Nanosecond Timing Distribution over Ethernet*, ISPCS 2009, www.iiss.oeaw.ac.at/files/pub/Moreira2009.pdf
- J.Serrano et al., *The White Rabbit Project*, ICALEPCS 2009, accelconf.web.cern.ch/accelconf/icalpeps2009/papers/tuc004.pdf
- [7] WR-supplier: SevenSols, Spain, <http://www.sevensols.com/>
- [8] WR-supplier: Creotech, Poland, <http://www.creotech.pl/en>
- [9] M.Brückner and R.Wischniewski, "A White Rabbit setup for sub-nsec synchronization, timestamping and time calibration in large scale astroparticle physics experiments", these proceedings ID-1146
- [10] F.Schroeder, *Radio-Beacon method*
- [11] K.Bernlöhr et al. (for the CTA-consortium), *Astroparticle Physics* 43 (2013) 171-188.